



SANDEN

**COMPRESSORES
PARA VEÍCULOS
INDUSTRIAIS
E AGRÍCOLAS**

*COMPRESSORES
FOR INDUSTRIAL AND
FARM VEHICLES*

COMPRESSOR ORIGINAL DAF-TRUCKS



Codigo C.88.07.379.A
Mod. SANDEN SD7H15 - 7856-8051-8127
Frizione / Clutch 1 Gola A ø133
Attacchi / Fittings Pad orizzontale
Utilizzo / Applic. **DAF XF**
Cod. O.E.M. 1444295



Codigo C.88.07.380.A
Mod. SANDEN SD7H15 - 8129
Frizione / Clutch Poly-V8 ø123
Attacchi / Fittings Pad orizzontale
Utilizzo / Applic. **DAF XF**
Cod. O.E.M. 1387322

COMPRESSOR ORIGINAL FIAT

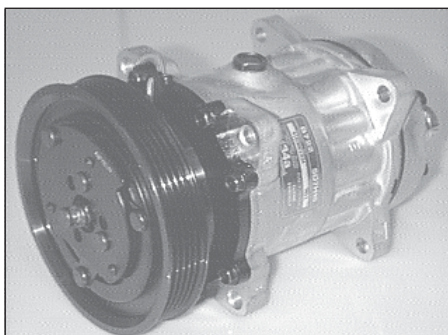

Codigo C.88.07.262.A
Mod. SANDEN SD7H15 - 7811
Frizione / Clutch Poly-V5 ø135
Attacchi / Fittings Rotolock
Utilizzo / Applic. **Ducato 2.0 TD i.d.**
Cod. O.E.M. 7761693

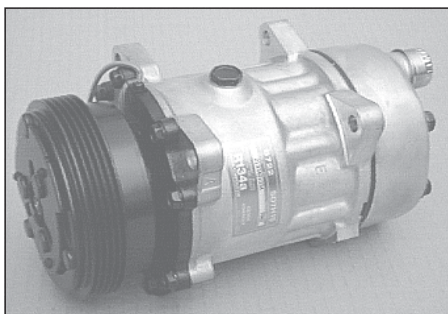

Codigo C.88.07.289.A
Mod. SANDEN SD7H15 - 7882
Frizione / Clutch Poly-V5 ø117
Attacchi / Fittings Rotolock
Utilizzo / Applic. **Ducato 2,5 TD - 2,8 TD**
Cod. O.E.M. -

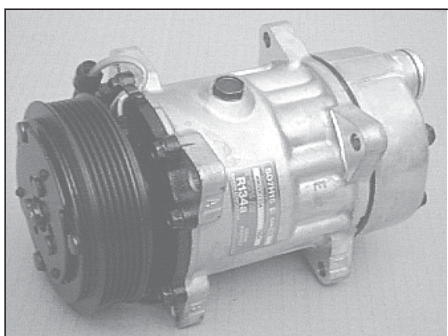

Codigo C.88.07.294.A
Mod. SANDEN SD7H15 - 7854
Frizione / Clutch Poly-V6
Attacchi / Fittings Flangia / B.Pad
Utilizzo / Applic. **Ducato Sevel**
Cod. O.E.M. -

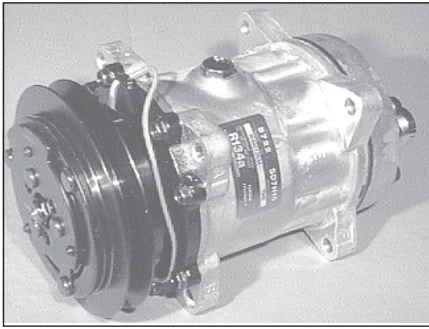

Codigo
Mod. **SANDEN**
Frizione / Clutch
Attacchi / Fittings
Utilizzo / Applic.
Cod. O.E.M.

C.88.07.277.A
SD7H15 - 7948
1 Gola ø135 24V
Rotolock orizzontale
TurboStar - Eurocargo - EuroStar - EuroTech
98462948



Codigo
Mod. **SANDEN**
Frizione / Clutch
Attacchi / Fittings
Utilizzo / Applic.
Cod. O.E.M.

C.88.07.333.A
SD7H15-8090-8144
Poly-V8 24V
Rotolock orizzontale
Eurocargo - Tector
4894306

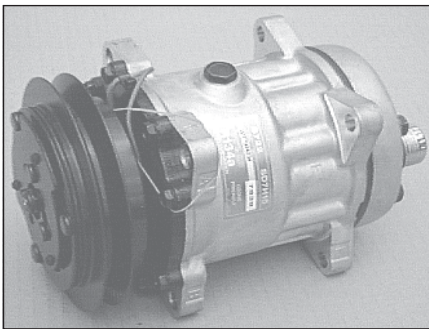

Codigo
Mod. **SANDEN**
Frizione / Clutch
Attacchi / Fittings
Utilizzo / Applic.
Cod. O.E.M.

C.88.07.335.A
SD7H15 - 7939
1 Gola ø135 12V
Rotolock orizzontale
Daily
-

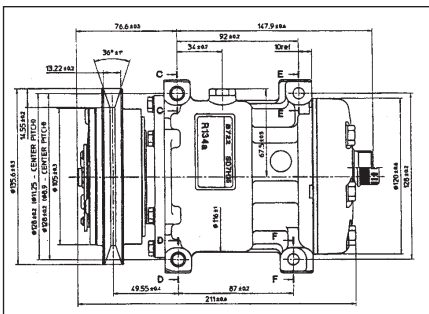

Codigo
Mod. **SANDEN**
Frizione / Clutch
Attacchi / Fittings
Utilizzo / Applic.
Cod. O.E.M.

C.88.07.384.A
SD7H15 - 8133
1 Gola ø135 24V
Rotolock Orizzontale
Bus
-

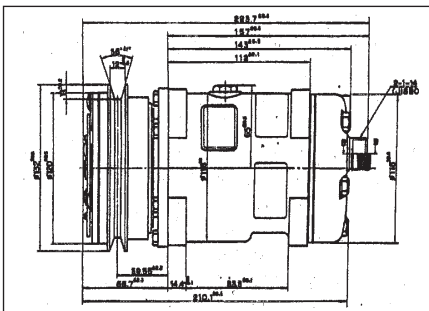

Codigo
Mod. **SANDEN**
Frizione / Clutch
Attacchi / Fittings
Utilizzo / Applic.
Cod. O.E.M.

C.88.07.449.A
SD510 - 9521
1 Gola ø132 24V
Rotolock Orizzontale
TurboStar
4810576

Figura non disponibile

Codigo
Mod. **SANDEN**
Frizione / Clutch
Attacchi / Fittings
Utilizzo / Applic.
Cod. O.E.M.

C.88.07.453.A
SD5H14
1 Gola 24V
Rotolock
TurboStar
4791134

Figura non disponibile

Codigo
Mod. **DENSO**
Frizione / Clutch
Attacchi / Fittings
Utilizzo / Applic.
Cod. O.E.M.

C.88.16.223.A
SC 08 scroll

Daily new
500313156



Codigo
Mod. **DENSO**
Frizione / Clutch
Attacchi / Fittings
Utilizzo / Applic.
Cod. O.E.M.

C.88.16.224.A
ND 10PA17
Poly-V4 ø113
Flangia / B.Pad
Cursor 8
99488569



Codigo
Mod. **DENSO**
Frizione / Clutch
Attacchi / Fittings
Utilizzo / Applic.
Cod. O.E.M.

C.88.16.225.A
ND 10PA17
Poly-V4 ø124
Flangia / B.Pad
Cursor 10/13
98497470

COMPRESSOR ORIGINAL KONVEKTA

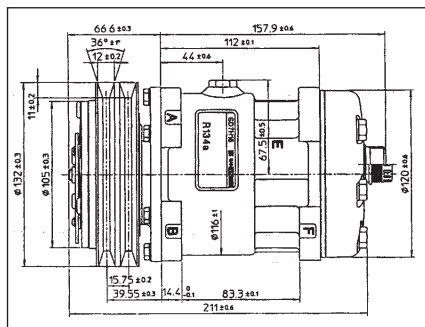

Codigo
 Mod. **SANDEN**
 Frizione / Clutch
 Attacchi / Fittings
 Utilizzo / Applic.
 Cod. O.E.M.

C.88.07.391.A
 SD7H15 - 7933
 2 Gole \varnothing 132 24V
 Rotolock Orizzontale
Bus
 -

COMPRESSOR ORIGINAL MAN



Codigo
 Mod. **SANDEN**
 Frizione / Clutch
 Attacchi / Fittings
 Utilizzo / Applic.
 Cod. O.E.M.

C.88.07.415.A
 SD7H15 - 8117
 Poly-V8 \varnothing 123 24V
 Rotolock
MAN Truck
 -

Codigo

Mod. **DENSO**
 Frizione / Clutch
 Attacchi / Fittings
 Utilizzo / Applic.
 Cod. O.E.M.

C.88.16.103.A

ND 7SB16
 Poly-V6 ø125
 Flangia / B.Pad
Vito - Sprinter '95>
 447100-682/447200-962

Codigo

Mod. **DENSO**
 Frizione / Clutch
 Attacchi / Fittings
 Utilizzo / Applic.
 Cod. O.E.M.

C.88.16.105.A

ND 10PA15C
 1 Gola A 24V
 Flangia / B.Pad
Ecoliner
 0002340811/0128

Codigo

Mod. **DENSO**
 Frizione / Clutch
 Attacchi / Fittings
 Utilizzo / Applic.
 Cod. O.E.M.

C.88.16.106.A

ND 10PA15C
 Poly-V9 24V
 Flangia / B.Pad
Actros
 A 541 230 00 11 / 0002340811



Codigo **C.88.07.429.A**
 Mod. **SANDEN** SD7H15 - 7913
 Frizione / Clutch Poly-V6
 Attacchi / Fittings
 Utilizzo / Applic. **AE Magnum**
 Cod. O.E.M. 5010-237-488



Codigo **C.88.07.430.A**
 Mod. **SANDEN** SD7H15 - 7970/8095
 Frizione / Clutch 2 Gole
 Attacchi / Fittings
 Utilizzo / Applic. **AE Magnum**
 Cod. O.E.M. 5010-240-457 / 5010-483-009



Codigo **C.88.07.431.A**
 Mod. **SANDEN** SD7H15 - 8081
 Frizione / Clutch 2 Gole
 Attacchi / Fittings
 Utilizzo / Applic. **Midium M100**
 Cod. O.E.M. 5010-417-679



Codigo **C.88.07.432.A**
 Mod. **SANDEN** SD7H15 - 8093
 Frizione / Clutch Poly-V5
 Attacchi / Fittings
 Utilizzo / Applic. **Premium - Kerax**
 Cod. O.E.M. 5010-412-961



Codigo **C.88.07.433.A**
 Mod. **SANDEN** SD7H15 - 8119
 Frizione / Clutch 2 Gole
 Attacchi / Fittings
 Utilizzo / Applic. **Midium M120**
 Cod. O.E.M. 5010-483-030



Codigo
 Mod. **SANDEN**
 Frizione / Clutch
 Attacchi / Fittings
 Utilizzo / Applic.
 Cod. O.E.M.

C.88.07.523.A
 SD7H15 - 8005
 Poly-V5
 Flangia / B.Pad
Master
 -



Codigo
 Mod. **SANDEN**
 Frizione / Clutch
 Attacchi / Fittings
 Utilizzo / Applic.
 Cod. O.E.M.

C.88.07.524.A
 SD7H15 - 8131
 Poly-V5 ø123
 Flangia / B.Pad
Premium
 5010-483-099



Codigo	C.88.07.283.A
Mod. SANDEN	SD5H14 - 6627
Frizione / Clutch	2 Gole ø132 24V
Attacchi / Fittings	O.Ring
Utilizzo / Applic.	142 - 143



Codigo	C.88.07.362.A
Mod. SANDEN	SD7H15 - 7980
Frizione / Clutch	Poly-V8 24V
Attacchi / Fittings	Flangia inclinata
Utilizzo / Applic.	144
Cod. O.E.M.	1376998



Codigo	C.88.07.364.A
Mod. SANDEN	SD7H15 - 7981
Frizione / Clutch	2 Gole ø132 24V
Attacchi / Fittings	Flangia / B.Pad
Utilizzo / Applic.	SCANIA
Cod. O.E.M.	1376999

COMPRESSOR ORIGINAL VOLKSWAGEN

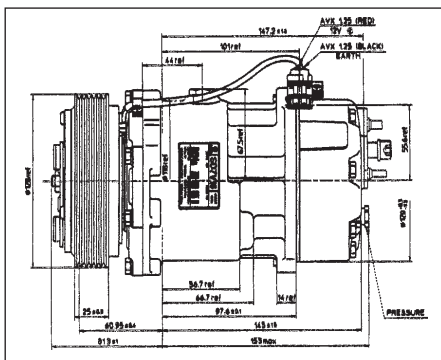

Codigo
Mod. **SANDEN**
Frizione / Clutch
Attacchi / Fittings
Utilizzo / Applic.
Cod. O.E.M.

C.88.07.423.A
SD7V16 - 1207/1246
Poly-V6 ø128
Pad orizzontale
VW Caravelle - Transporter 2.5 D
7D0820805C/G



Codigo
Mod. **SANDEN**
Frizione / Clutch
Attacchi / Fittings
Utilizzo / Applic.
Cod. O.E.M.

C.88.07.463.A
SD7V16 - 1145
Poly-V6
Flangia / B.Pad
VW Caravelle - Transporter 2.5 D
7D0820805

COMPRESSOR ORIGINAL VOLVO

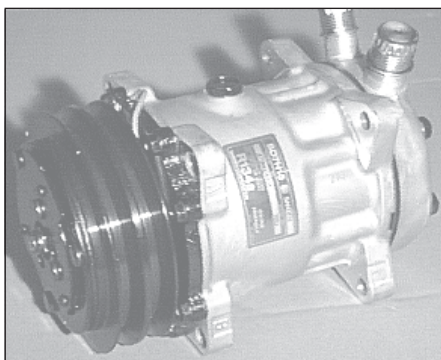

Codigo
Mod. **SANDEN**
Frizione / Clutch
Attacchi / Fittings
Utilizzo / Applic.
Cod. O.E.M.

C.88.07.287.A
SD7H15
2 Gole ø132 24V
O.Ring
Truck F12 - F16
1593151



Codigo
Mod. **SANDEN**
Frizione / Clutch
Attacchi / Fittings
Utilizzo / Applic.
Cod. O.E.M.

C.88.07.363.A
SD7H15 - 8044
Poly-V8 ø132 24V
Flangia / B.Pad
Truck 12 cil.
8191892



Codigo **C.88.07.387.A**
 Mod. **SANDEN** SD7H15 - 8003
 Frizione / Clutch Poly-V8 ø136
 Attacchi / Fittings Pad orizzontale
 Utilizzo / Applic. **Truck 6/12 cil.**
 Cod. O.E.M. 3962650



Codigo **C.88.07.388.A**
 Mod. **SANDEN** SD7H15 - 7834
 Frizione / Clutch Poly-V8 ø136
 Attacchi / Fittings O.Ring
 Utilizzo / Applic. **FH 16**
 Cod. O.E.M. 8142555



Codigo **C.88.07.495.A**
 Mod. **SANDEN** SD7H15 - 7972/7808
 Frizione / Clutch 2 Gole
 Attacchi / Fittings O.Ring
 Utilizzo / Applic. **Truck**
 Cod. O.E.M. 1593151



Codigo **C.88.07.496.A**
 Mod. **SANDEN** SD7H15 - 8045
 Frizione / Clutch 2 Gole
 Attacchi / Fittings Pad orizzontale
 Utilizzo / Applic. **Truck**
 Cod. O.E.M. -

ZEXEL

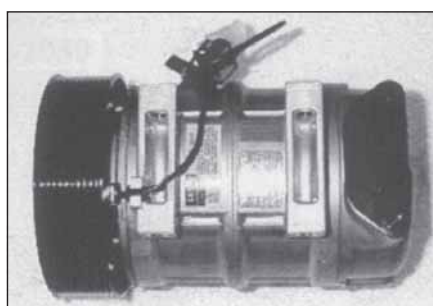

Codigo **C.88.16.199.A**
 Mod. **ZEXEL**
 Frizione / Clutch Poly-V
 Attacchi / Fittings O.Ring
 Utilizzo / Applic. **FH 7**
 Cod. O.E.M. -

COMPRESSOR ORIGINAL CASE



Codigo C.88.07.254.A
Mod. SANDEN SD7H15 - 7862/8023
 Frizione / Clutch 2 Gole ø132
 Attacchi / Fittings Rotolock Orizzont.ale
 Utilizzo / Applic. 521 - 525 - 527 Combine
 Cod. O.E.M. -

COMPRESSOR ORIGINAL CATERPILLAR



Codigo C.88.07.417.A
Mod. SANDEN SD7H15 - 8064/4656
 Frizione / Clutch 1 Gola
 Attacchi / Fittings Flangia / B.Pad
 Utilizzo / Applic. **Veicoli mov.terra**
 Cod. O.E.M. -



Codigo C.88.07.471.A
Mod. SANDEN SD7H15 - 4611
 Frizione / Clutch 2 Gole ø152 24V
 Attacchi / Fittings Testata MD
 Utilizzo / Applic. **Veicoli mov.terra**
 Cod. O.E.M. -



Codigo C.88.07.389.A
Mod. SANDEN SD7H15 - 4637
 Frizione / Clutch Poly-V8 ø133
 Attacchi / Fittings O.Ring
 Utilizzo / Applic. **Veicoli mov.terra**
 Cod. O.E.M. -



Codigo C.88.07.508.A
Mod. SANDEN SD7H15 - 8066
 Frizione / Clutch 1 Gola ø154
 Attacchi / Fittings Flangia / B.Pad
 Utilizzo / Applic. **Veicoli mov.terra**
 Cod. O.E.M. -

COMPRESSOR PARA VEÍCULOS AGRICULAS
 COMPRESSORS FOR FARM VEHICLES

COMPRESSOR ORIGINAL CLAAS

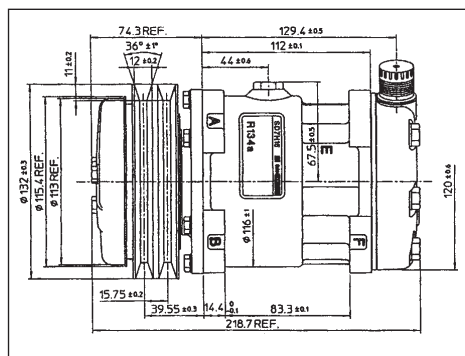

Codigo
 Mod. **SANDEN**
 Frizione / Clutch
 Attacchi / Fittings
 Utilizzo / Applic.

C.88.07.422.A
 SD7H15 - 8018
 2 Gole \varnothing 132 24V
 O-Ring
Ranger 920 - 925 - 928
964 - 975 - 960 - 970

Cod. O.E.M.

-

COMPRESS. ORIG. MASSEY-FERGUSON



Codigo
 Mod. **SANDEN**
 Frizione / Clutch
 Attacchi / Fittings
 Utilizzo / Applic.
 Cod. O.E.M.

C.88.07.206.A
 SD7H15 - 7851
 2 Gole \varnothing 132
 Rotolock Orizzontale
373 - 374 - 383 - 384 - 393 - 394
 3550921 M91



Codigo C.88.07.233.A
Mod. SANDEN SD5H14 - 6631
 Frizione / Clutch 2 Gole \varnothing 132
 Attacchi / Fittings Rotolock Orizzontale
 Utilizzo / Applic. Tn 55 - 65 - 75
 Cod. O.E.M. 5176185



Codigo C.88.07.257.A
Mod. SANDEN SD7H15 - 7890/8028
 Frizione / Clutch Poly-V8 \varnothing 119
 Attacchi / Fittings O.Ring 7/8" - 3/4"
 Utilizzo / Applic. 60 series - M series - Tm series
 Cod. O.E.M. 82002069



Codigo C.88.07.331.A
Mod. SANDEN SD7H15 - 7929
 Frizione / Clutch 2 Gole \varnothing 132
 Attacchi / Fittings Rotolock Verticale
 Utilizzo / Applic. New-Holland
 Cod. O.E.M. -

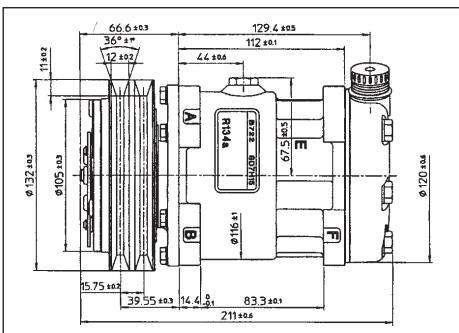

Codigo C.88.07.336.A
Mod. SANDEN SD7H15 - 7928
 Frizione / Clutch 2 Gole \varnothing 132 12V
 Attacchi / Fittings Rotolock Verticale
 Utilizzo / Applic. New-Holland
 Cod. O.E.M. -



Codigo C.88.07.337.A
Mod. SANDEN SD7H15 - 8023/7862
 Frizione / Clutch 2 Gole \varnothing 132
 Attacchi / Fittings Rotolock Orizzontale
 Utilizzo / Applic. Tc combine - Fx 300 - 375 - 450
 Tx 62 - 64 - 65 - 66 - 68 combine
 Cod. O.E.M. 89831429/84018078



Codigo
Mod. **ND**
Frizione / Clutch
Attacchi / Fittings
Utilizzo / Applic.
Cod. O.E.M.

C.88.16.074.A
10PA15C
Poly-V8
Flangia / B.Pad
Trattore 6000
-



Codigo
Mod. **ND**
Frizione / Clutch
Attacchi / Fittings
Utilizzo / Applic.
Cod. O.E.M.

C.88.16.075.A
10PA15C
2 Gole A
Flangia / B.Pad
Mietitrebbia
-